

Marwi item: CB-021
Standard bearing number: 686 2RS
Dimension (mm): 6 x 13 x 5

Scale 1:1

Scale 5:1

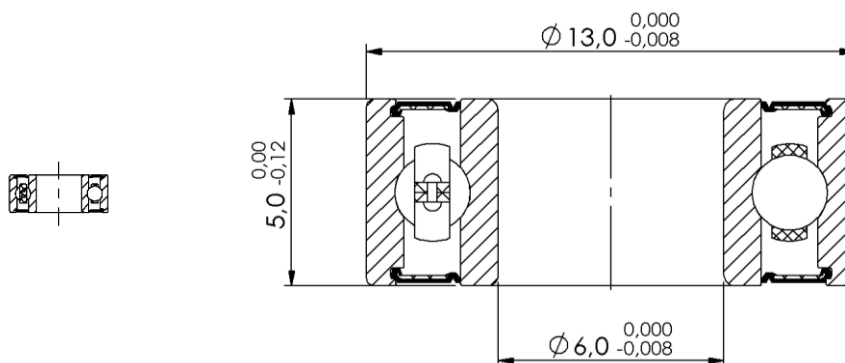

Technical specifications:

Races:	CrMo
Balls:	CrMo (HRC 61-66)
Retainer:	Steel
Sealing:	Rubber 2RS (light contact)
Grease:	Multemp SRL (Kyodo Yushi)
Tolerance:	ABEC-3
Quantity of balls:	8 pcs
Dimension of balls:	2,0mm
Basic dynamic load rating:	1,082 kN
Basic static load rating:	0,442 kN

Applications:

Frame (suspension pivot):	Various brands
Pedal:	Various brands