

Marwi item: CB-071
Standard bearing number: 6801 2RS
Dimension (mm): 12 x 21 x 5

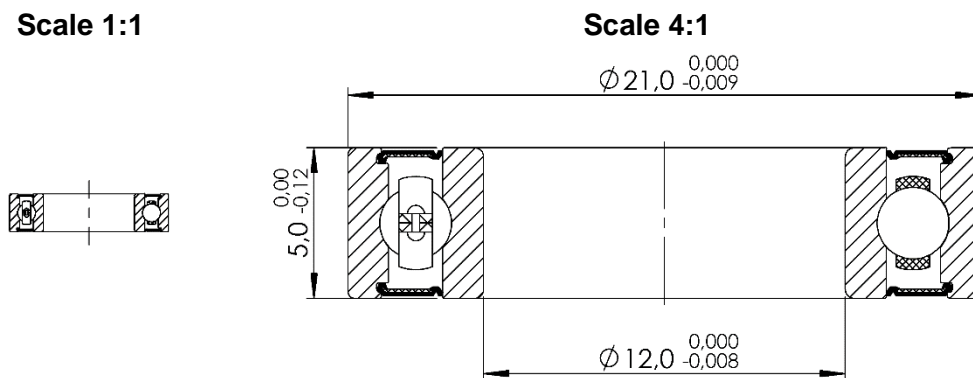

Technical specifications:

Races:	CrMo
Balls:	CrMo (HRC 61-66)
Retainer:	Steel
Sealing:	Rubber 2RS (light contact)
Grease:	Multemp SRL (Kyodo Yushi)
Tolerance:	ABEC-3
Quantity of balls:	12 pcs
Dimension of balls:	2,381mm (1/16")
Basic dynamic load rating:	1,920 kN
Basic static load rating:	1,040 kN

Applications:

Hub / wheel:	Various brands
Frame (suspension pivot):	Various brands