

Marwi item: CB-082
Standard bearing number: 63802 2RS
Dimension (mm): 15 x 24 x 7

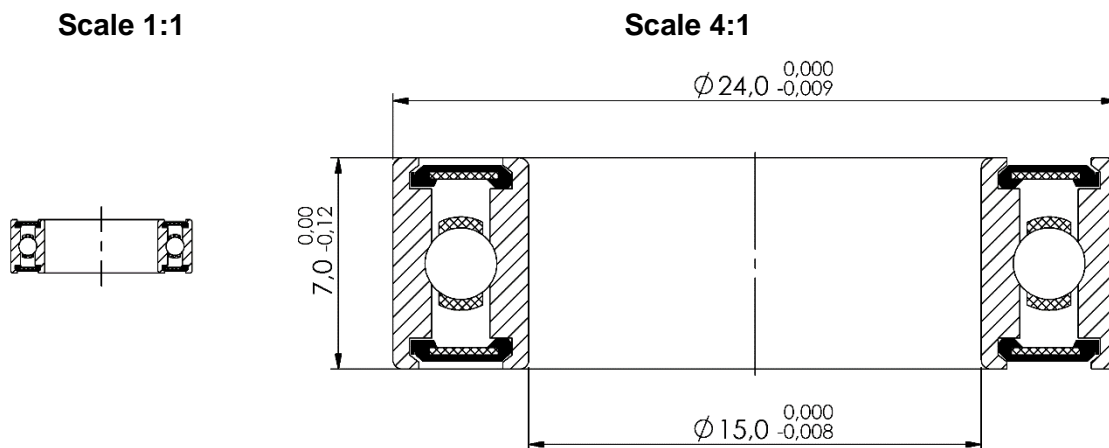

Technical specifications:

Races:	CrMo
Balls:	CrMo (HRC 61-66)
Retainer:	Steel
Sealing:	Rubber 2RS (light contact)
Grease:	Multemp SRL (Kyodo Yushi)
Tolerance:	ABEC-3
Quantity of balls:	14 pcs
Dimension of balls:	2,381mm (3/32")
Basic dynamic load rating:	2,073 kN
Basic static load rating:	1,250 kN

Applications:

Hub / wheel:	Various brands
Frame (suspension pivot):	Various brands