

Marwi item: CB-134
Standard bearing number: 6904 2RS
Dimension (mm): 20 x 37 x 9

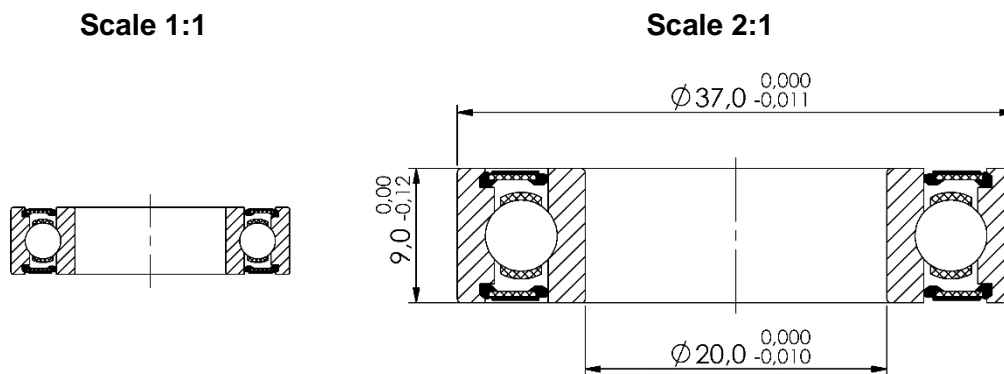

Technical specifications:

Races:	CrMo
Balls:	CrMo (HRC 61-66)
Retainer:	Steel
Sealing:	Rubber 2RS (light contact)
Grease:	Multemp SRL (Kyodo Yushi)
Tolerance:	ABEC-3
Quantity of balls:	11 pcs
Dimension of balls:	4,762mm (3/16")
Basic dynamic load rating:	6,400 kN
Basic static load rating:	3,700 kN

Applications:

Hub / wheel:	Various brands
Frame (suspension pivot):	Various brands