

Marwi item: CB-332
Standard bearing number: 6801 ceramic LLB
Dimension (mm): 12 x 21 x 5

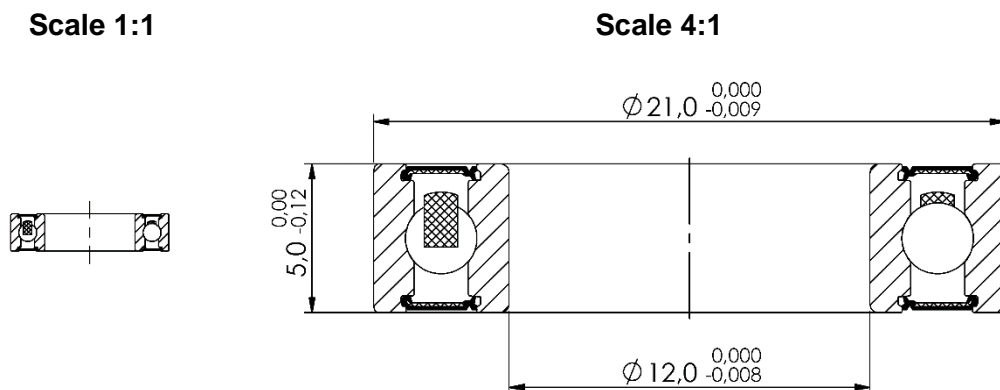

Technical specifications:

Races:	CrMo
Balls:	Si ₃ N ₄ Silicon Nitride (HRC 75-89)
Retainer:	Nylon
Sealing:	Rubber LBB (non contact)
Grease:	Multemp PS2 (Kyodo Yushi)
Tolerance:	ABEC-5
Quantity of balls:	12 pcs
Dimension of balls:	2,381mm (1/8")
Basic dynamic load rating:	1,920 kN
Basic static load rating:	1,040 kN

Applications:

Hub / wheel: Various brands