

**Marwi item:** CB-745  
**Dimension (mm):** 33,05 x 43,8 x 7,0  
**Angle:** 30° / 45°

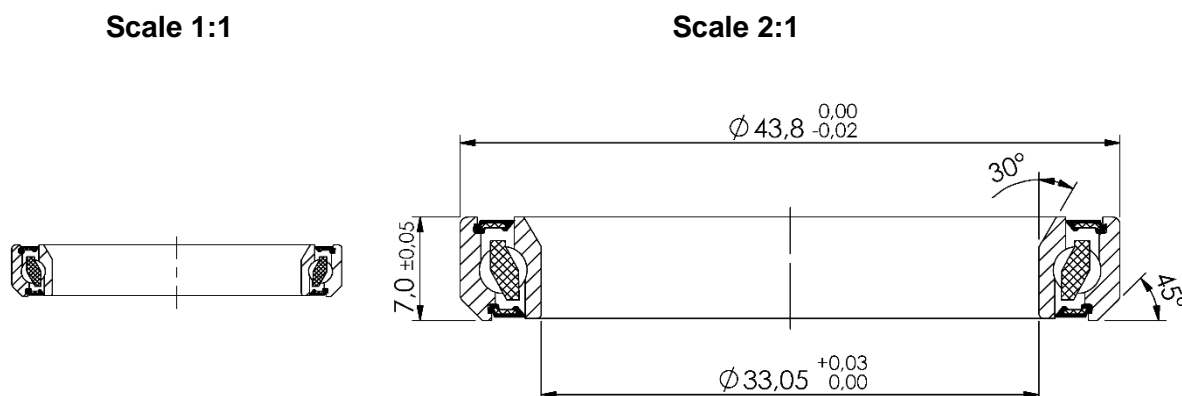

### Technical specifications:

<b>Races:</b>	CrMo
<b>Balls:</b>	CrMo (HRC 61-66)
<b>Retainer:</b>	Nylon
<b>Sealing:</b>	Rubber LLU (full contact)
<b>Grease:</b>	Multemp SRL (Kyodo Yushi)
<b>Tolerance:</b>	ABEC-3
<b>Quantity of balls:</b>	23 pcs
<b>Dimension of balls:</b>	3,175mm (1/8")
<b>Basic dynamic load rating:</b>	3,130 kN
<b>Basic static load rating:</b>	2,480 kN

### Applications:

**Headset:** Various brands