

Marwi item: CB-764
Dimension (mm): 37,0 x 48,0 x 6,5
Angle: 36° / 45°

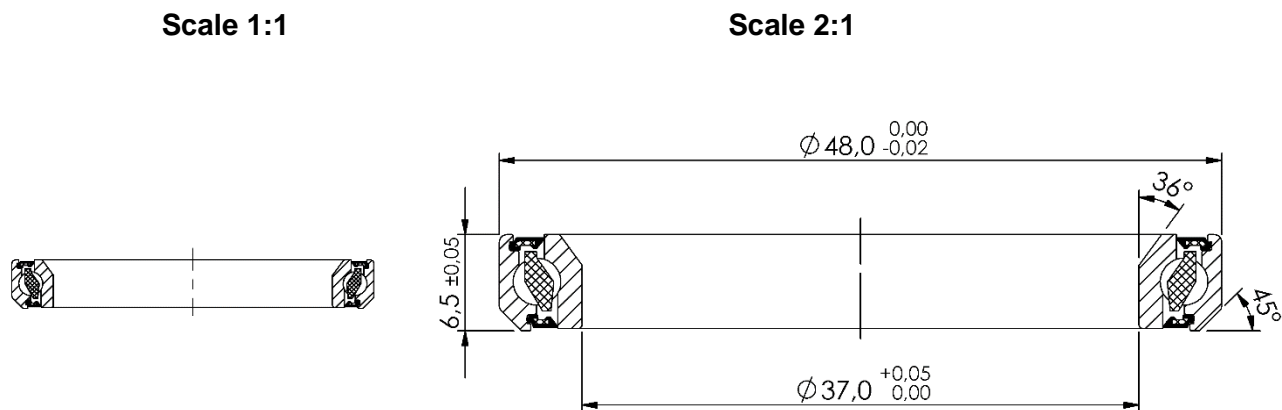

Technical specifications:

Races:	CrMo
Balls:	CrMo (HRC 61-66)
Retainer:	Nylon
Sealing:	Rubber LLU (full contact)
Grease:	Multemp SRL (Kyodo Yushi)
Tolerance:	ABEC-3
Quantity of balls:	30 pcs
Dimension of balls:	3,175mm (1/8")
Basic dynamic load rating:	2,440 kN
Basic static load rating:	2,110 kN

Applications:

Headset: Various brands